

Digital temperature transmitter

With HART® protocol, head and rail-mounted version

Model T38

WIKA data sheet TE 38.01



For further approvals, see page 12



Applications

- Process industry
- Machine building and plant construction

Special features

- TÜV certified SIL version for protection systems developed per IEC 61508 (option)
- Operation in safety applications to SIL 2 (single instrument) and SIL 3 (redundant configuration)
- Configurable with almost all soft- and hardware tools
- Universal for the connection of 1 or 2 sensors: Resistance thermometer (up to 2 x 3-wire), Thermocouple, resistance sensor, Thermocouple, Voltage sensor, Potentiometer, Reed chains
- Signalling in accordance with NAMUR NE43, sensor monitoring in accordance with NE89, EMC in accordance with NE21, self-monitoring and diagnostics of field instruments in accordance with NE107

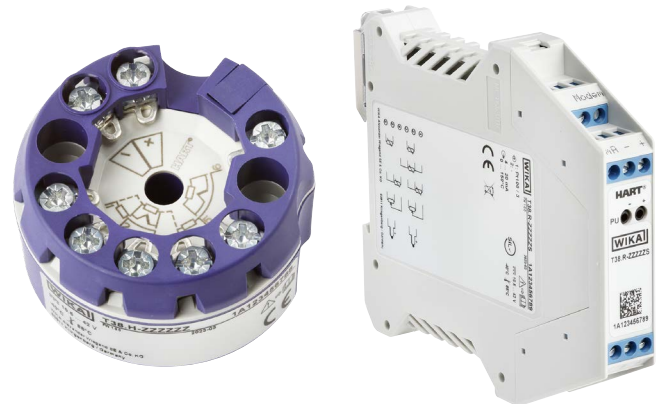

Fig. left: head-mounted version, model T38.H
Fig. right: rail-mounted version, model T38.R

Description

These temperature transmitters are designed for universal use in the process industry. They offer high accuracy through sensor-transmitter matching, highest reliability and excellent protection against electromagnetic influences. Via HART® protocol, the T38 temperature transmitters are configurable (interoperable) with a variety of open configuration tools. In addition, the T38 temperature transmitters, via the WIKAsoft-TT configuration software with model PU-548 programming unit, can be parameterised very easily, quickly and with a clear overview.

Besides the selection of the sensor type and the measuring range, the software enables the error signalling operation, damping, several measuring location descriptions and process adjustment to be stored. The T38 transmitters offer a wide range of sensor connection combinations.

Through the configuration of a sensor with redundancy (dual sensor), on a sensor failure it will automatically change over to the working sensor. Furthermore, there is the possibility to activate sensor drift detection. With the WIKA True Drift Detection technology, sensors can be monitored continuously, and erroneous measuring locations can be identified immediately.

Additionally, the T38 transmitters also have numerous sophisticated supervisory functionalities such as monitoring of the sensor lead resistance and sensor break monitoring in accordance with NAMUR NE89 as well as monitoring of the measuring range. In addition, extended diagnostic functions in accordance with NE107 are integrated and extensive cyclical self-monitoring functions are carried out, which contribute to the high level of system security.

Specifications

Measuring element				
	Sensor type	Max. configurable measuring range	Standard	Min. measuring span (MS) ¹⁾
Resistance sensor	Pt100	-200 ... +850 °C [-328 ... +1,562 °F]	IEC 60751	10 K
	Pt1000	-200 ... +850 °C [-328 ... +1,562 °F]	IEC 60751	
	CvD	-200 ... +850 °C [-328 ... +1,562 °F]	n. a.	
	Pt1000 Cryogenic design ²⁾	-260 ... +200 °C [-436 ... +392 °F]	Internal + IEC 60751	
	JPt100	-200 ... +500 °C [-328 ... +932 °F]	JIS C1606:1989	
	JPt1000	-200 ... +500 °C [-328 ... +932 °F]	JIS C1606:1989	
	Ni100	-60 ... +250 °C [-76 ... +482 °F]	DIN 43760:1987	
	Resistance sensor ²⁾	0 ... 4,100 Ω	n.a.	20 Ω
Potentiometer ³⁾	Potentiometer ²⁾	0 ... 100 %	n.a.	10 %
FLR sensor ³⁾	Reed chains	0 ... 100 %	n.a.	10 %
Thermocouple type	J	-210 ... +1,200 °C [-346 ... +2,192 °F]	IEC 60584-1	50 K
	K	-270 ... +1,300 °C [-454 ... +2,372 °F]	IEC 60584-1	
	L (DIN)	-200 ... +900 °C [-328 ... +1,652 °F]	DIN 43710:1985	
	L (GOST)	-200 ... +800 °C [-328 ... +1,472 °F]	GOST R 8.585 - 2001	
	E	-270 ... +1,000 °C [-454 ... +1,832 °F]	IEC 60584-1	
	N	-270 ... +1,300 °C [-454 ... +2,372 °F]	IEC 60584-1	
	T	-270 ... +400 °C [-454 ... +752 °F]	IEC 60584-1	
	U	-200 ... +600 °C [-328 ... +1,112 °F]	DIN 43710:1985	
	R	-50 ... +1,768 °C [-58 ... +3,214 °F]	IEC 60584-1	150 K
	S	-50 ... +1,768 °C [-58 ... +3,214 °F]	IEC 60584-1	
	B	-50 ... +1,820 °C [-58 ... +3,308 °F]	IEC 60584-1	200 K
	C	-50 ... +2,315 °C [-58 ... +4,199 °F]	IEC 60584-1	150 K
	A	-50 ... +2,500 °C [-58 ... +4,532 °F]	IEC 60584-1	
	Voltage sensor	mV sensor ²⁾	-500 ... +1,000 mV	-

1) The transmitter can be configured below these limit values, but this is not recommended due to loss of accuracy.

2) This operating mode is not allowed for the SIL option.

3) R_{total} : 1 ... 35 kΩ

Further details on: Measuring element	
Measuring current during measurement	Max. 0.33 mA (Pt100)
Connection methods	
Resistance thermometer (RTD)	<ul style="list-style-type: none"> ■ 1 sensor in 2-/3-/4-wire connection ■ 2 sensors in 2-/3-wire connection → For further information, see “Assignment of connection terminals”
Thermocouple (TC), FLR, potentiometer, voltage sensor	<ul style="list-style-type: none"> ■ 1 sensor ■ 2 sensors → For further information, see “Assignment of connection terminals”
Resistance sensor	<ul style="list-style-type: none"> ■ 1 sensor in 2-/3-/4-wire connection ■ 2 sensors in 2-/3-wire connection
Resistance thermometer (RTD) and thermocouple (TC)	<ul style="list-style-type: none"> ■ Sensor 1 in 4-wire connection ■ Sensor 2 thermocouple
Thermocouple (TC) and resistance thermometer (RTD)	<ul style="list-style-type: none"> ■ Sensor 1 thermocouple ■ Sensor 2 in 2-/3-wire connection
Cold junction compensation, configurable	<ul style="list-style-type: none"> ■ Internal compensation ■ External with Pt100 ■ Fixed valued with fixed temperature specification ■ Disabled

Versioning per NAMUR NE53

Version	T38.x HART® instrument version	Corresponding DD (Device Description)
1.0.1	1	Dev v1, DDv1

Overall instrument accuracy

The product-specific accuracy specifications refer to the overall instrument. To determine the total error, all possible types of error must be considered - these are summarised in the following table.

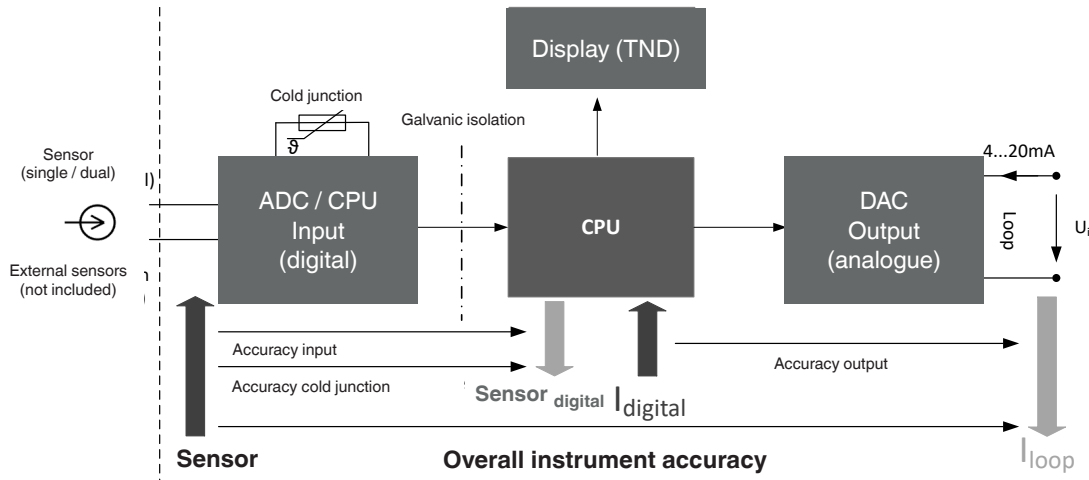

Accuracy specifications				
Input and output in accordance with IEC 62828				
Input sensor type	Mean temperature coefficient for each 10 K change in ambient temperature in the range -40 ... +85 °C [-40 ... +185 °F]	Measuring deviation at reference conditions ¹⁾ in accordance with EN IEC 62828, NE 145, valid at 23 °C [73 °F] ±3 K	Influence of lead resistance	Long-term stability after 1 year at reference conditions ¹⁾
Pt100 / Pt1000 ²⁾ / JPt100 / JPt1000 / Ni100	±(0.06 K + 0.015 % MV)	-200 °C [-328 °F] ≤ MV ≤ +200 °C [+392 °F]: ±0.10 K MV > +200 °C [+392 °F]: ±(0.1 K + 0.01 % IMV-200 K)	4-wire: no effect (0 ... 50 Ω per wire) 3-wire: ±0.02 Ω / 10 Ω (0 ... 50 Ω per wire) 2-wire: resistance of the supply lines ³⁾	±60 mΩ or 0.05 % of MV, greater value applies
Pt1000 cryogenic design		-260 ... -200 ±(0.1 K + 0.6 % IMV+200 K) -200 ... +200 ± 0.1 K		
Resistance sensor	±(0.01 Ω + 0.01 % MV)	4-wire: 0 °C ≤ MV ≤ +250 °C [482 °F]: ±0.05 Ω MV > +250 °C [482 °F]: ±(MV * 0.02 %) Ω 3-wire: 0 °C ≤ MV ≤ +250 °C [482 °F] ±0.05 Ω MV > +250 °C [482 °F]: ±(MV * 0.02 %) Ω		
Potentiometer	±(0.1 % MV)	R_{part}/R_{total} is max. ±0.5 %	-	-
FLR sensor	±(0.1 % MV)	R_{part}/R_{total} is max. ±0.2 % ⁴⁾	-	±(0.1 % MV)
Thermocouples				
Type J (Fe-CuNi)	MV > -150 °C [-238 °F]: ±(0.07 K + 0.02 % IMV)	-150 °C [-238 °F] < MV < 0 °C [+32 °F]: ±(0.3 K + 0.2 % IMV) MV > 0 °C [+32 °F]: ±(0.3 K + 0.03 % MV)	6 μV / 1,000 Ω	±20 μV or 0.05 % of MV, greater value applies

Accuracy specifications				
Input and output in accordance with IEC 62828				
Input sensor type	Mean temperature coefficient for each 10 K change in ambient temperature in the range -40 ... +85 °C [-40 ... +185 °F]	Measuring deviation at reference conditions ¹⁾ in accordance with EN IEC 62828, NE 145, valid at 23 °C [73 °F] ±3 K	Influence of lead resistance	Long-term stability after 1 year at reference conditions ¹⁾
Type K (NiCr-Ni)	MV > -150 °C [-238 °F]: ±(0.1 K + 0.02 % IMVI)	-150 °C [-238 °F] < MV < 0 °C [+32 °F]: ±(0.4 K + 0.2 % IMVI) MV > 0 °C [+32 °F]: ±(0.4 K + 0.04 % MV)	6 μV / 1,000 Ω	±20 μV or 0.05 % of MV, greater value applies
Type L (DIN / Fe-CuNi)	MV > 0 °C [+32 °F]: ±(0.07 K + 0.015 % MV)	MV > 0 °C [+32 °F]: ±(0.3 K + 0.03 % MV)	6 μV / 1,000 Ω	±20 μV or 0.05 % of MV, greater value applies
Type L (GOST / Fe-Cu-Ni)	MV > -150 °C [-238 °F]: ±(0.1 K + 0.015 % IMVI)	-150 °C [-238 °F] < MV < 0 °C [+32 °F]: ±(0.3 K + 0.2 % IMVI) MV > 0 °C [+32 °F]: ±(0.3 K + 0.03 % MV)	6 μV / 1,000 Ω	±20 μV or 0.05 % of MV, greater value applies
Type E (NiCr-Cu)	MV > -150 °C [-238 °F]: ±(0.1 K + 0.015 % IMVI)	-150 °C [-238 °F] < MV < 0 °C [+32 °F]: ±(0.3 K + 0.2 % IMVI) MV > 0 °C [+32 °F]: ±(0.3 K + 0.03 % MV)	6 μV / 1,000 Ω	±20 μV or 0.05 % of MV, greater value applies
Type N (NiCrSi-NiSi)	-150 °C [-238 °F] < MV < 0 °C [+32 °F]: ±(0.1 K + 0.05 % IMVI) MV > 0 °C [+32 °F]: ±(0.1 K + 0.02 % MV)	-150 °C [-238 °F] < MV < 0 °C [+32 °F]: ±(0.5 K + 0.2 % IMVI) MV > 0 °C [+32 °F]: ±(0.5 K + 0.03 % MV)	6 μV / 1,000 Ω	±20 μV or 0.05 % of MV, greater value applies
Type T (Cu-CuNi)	-150 °C [-238 °F] < MV < 0 °C [+32 °F]: ±(0.07 K + 0.04 % MV) MV > 0 °C [32 °F]: ±(0.07 K + 0.01 % MV)	-150 °C [-238 °F] < MV < 0 °C [+32 °F]: ±(0.4 K + 0.2 % IMVI) MV > 0 °C [+32 °F]: ±(0.4 K + 0.01 % MV)	6 μV / 1,000 Ω	±20 μV or 0.05 % of MV, greater value applies
Type U (Cu-CuNi)	MV > 0 °C [32 °F]: ±(0.07 K + 0.01 % MV)	MV > 0 °C [32 °F]: ±(0.4 K + 0.01 % MV)	6 μV / 1,000 Ω	±20 μV or 0.05 % of MV, greater value applies
Type R (PtRh-Pt)	MV > 50 °C [122 °F]: ±(0.3 K + 0.01 % IMV - 400 KI)	50 °C [122 °F] < MV < 400 °C [752 °F]: ±(1.45 K + 0.12 % IMV - 400 KI) MV > 400 °C [752 °F]: ±(1.45 K + 0.005 % IMV - 400 KI)	6 μV / 1,000 Ω	±20 μV or 0.05 % of MV, greater value applies
Type S (PtRh-Pt)	MV > 50 °C [122 °F]: ±(0.3 K + 0.015 % IMV - 400 KI)	50 °C [122 °F] < MV < 400 °C [752 °F]: ±(1.45 K + 0.12 % IMV - 400 KI) MV > 400 °C [752 °F]: ±(1.45 K + 0.01 % IMV - 400 KI)	6 μV / 1,000 Ω	±20 μV or 0.05 % of MV, greater value applies
Type B (PtRh-Pt)	450 °C [842 °F] < MV < 1,000 °C [1,832 °F]: ±(0.4 K + 0.02 % IMV - 1,000 KI) MV > 1,000 °C: ±(0.4 K + 0.005 % (MV - 1,000 K))	450 °C [842 °F] < MV < 1,000 °C [1,832 °F]: ±(1.7 K + 0.2 % IMV - 1,000 KI) MV > 1,000 °C: ±1.7 K	6 μV / 1,000 Ω	±20 μV or 0.05 % of MV, greater value applies
Type C (W5Re-W26Re)	0 °C [32 °F] < MV < 400 °C [752 °F]: ±0.25 K MV > 400 °C [752 °F]: ±(0.25 K + 0.05 % (MV - 400 K))	0 °C [32 °F] < MV < 400 °C [752 °F]: ±(0.85 K + 0.04 % IMV - 400 KI) MV > 400 °C [752 °F]: ±(0.85 K + 0.1 % IMV - 400 KI)	6 μV / 1,000 Ω	±20 μV or 0.05 % of MV, greater value applies

Accuracy specifications				
Input and output in accordance with IEC 62828				
Input sensor type	Mean temperature coefficient for each 10 K change in ambient temperature in the range -40 ... +85 °C [-40 ... +185 °F]	Measuring deviation at reference conditions ¹⁾ in accordance with EN IEC 62828, NE 145, valid at 23 °C [73 °F] ±3 K	Influence of lead resistance	Long-term stability after 1 year at reference conditions ¹⁾
Type A (W5Re-W20Re)	0 °C [32 °F] < MV < 400 °C [752 °F]: ± 0.25 K MV > 400 °C [752 °F] ±(0.25 K + 0.05 % (MV - 400 K))	0 °C [32 °F] < MV < 400 °C [752 °F] ±(0.85 K + 0.04 % IMV - 400 KI) MV > 400 °C [752 °F] ±(0.85 K + 0.1 % IMV - 400 KI)	6 µV / 1,000 Ω	±20 µV or 0.05 % of MV, greater value applies
mV sensor	±(2 µV + 0.02 % IMVI)	±(10 µV + 0.03 % IMVI)	6 µV / 1,000 Ω	±20 µV or 0.05 % of MV, greater value applies
Cold junction (only with TC)	±0.1 K	±0.8 K	-	±0.2 K
Output	±0.03 % of measuring span ⁵⁾	±0.03 % of measuring span	-	±0.05 % of span

1) Reference conditions: Temperature: 23 °C +/-3 °C, relative humidity: 50 - 70 %, ambient pressure: 86 - 106 kPa

2) Dual sensor only up to 450 °C [842 °F] within specification.

3) The specified resistance value of the sensor wire can be subtracted from the calculated sensor resistance. Dual sensor: configurable for each sensor separately.

4) For dual sensors, the doubled value can be taken.

5) Only for the range -40 ... +85 °C [-40 ... +185 °F], furthermore, the temperature coefficient error doubles to ±0.06 % of the measuring span.

Measuring span = configured end of measuring range - configured start of measuring range

Output signal		
Analogue output (configurable)	<ul style="list-style-type: none"> ■ 4 ... 20 mA, 2-wire ■ 20 ... 4 mA, 2-wire 	
Temperature linearity	For RTD	Linear to temperature per IEC 60751, JIS C1606, DIN 43760
	For TC	Linear to temperature per IEC 60584, DIN 43710, GOST R 8.585 - 2001
Load R_A	The permissible load depends on the loop supply voltage.	
With HART®	$R_A \leq (U_B - 10.5 \text{ V}) / 0.022 \text{ A}$ with R _A in Ω and U _B in V	
Output limits (configurable)		
In accordance with NAMUR NE43	Lower limit	3.8 mA
	Upper limit	20.5 mA
Customer-specifically adjustable	Lower limit	3.8 ... 4.0 mA
	Upper limit	20.0 ... 20.5 mA
Simulation	In simulation mode, independent from input signal, simulation value configurable from 3.5 ... 22.0 mA	
Current value for signalling		
In accordance with NAMUR NE43	Downscale	< 3.6 mA (3.5 mA) ¹⁾
	Upscale	> 20.5 mA (21.5 mA) ¹⁾
Setting range	Downscale	3.5 ... 3.6 mA
	Upscale	21.0 ... 22.0 mA
PV, primary value (digital HART® measured value)	Signalling on sensor and hardware error through default value [±9,999]	
Damping (configurable)	Configuration of 1 ... 60 s (0 = disabled) ¹⁾	
Factory configuration		
Sensor	Pt100	
Connection method	3-wire connection	
Measuring range	0 ... 150 °C [32 ... 302 °F]	
Damping	Disabled	
Error signalling	Downscale	

Output signal		
Output limits	Lower limit	3.8 mA
	Upper limit	20.5 mA
Communication		
Communication protocol	HART® protocol rev. 7.6	
	→ For further information, see page 3	
Integration software	HART® instrument driver and integration software	
	→ Free download from www.wika.com	
WIKA configuration software	WIKAsoft-TT	
	→ Free download from www.wika.com	
Configuration		
User linearisation	Store customer-specific sensor characteristics in the transmitter using software (other sensor types can be used in this way) Number of data points: min. 2 / max. 30	
Sensor functionality dual sensor	Sensor 1, sensor 2 redundant	The 4 ... 20 mA output signal delivers the process value of sensor 1. If sensor 1 fails, the process value of sensor 2 is output (sensor 2 is redundant).
	Sensor 1 redundant, sensor 2	The 4 ... 20 mA output signal delivers the process value of sensor 2. If sensor 2 fails, the process value of sensor 1 is output (sensor 1 is redundant).
	Sensor 1, sensor 2 digital	The 4 ... 20 mA output signal always delivers the process value of sensor 1. If sensor 1 fails, the transmitter switches to error signalling. Process values from sensor 2 can be queried via HART®.
	Mean value	The 4 ... 20 mA output signal delivers the mean value of the two values from sensor 1 and sensor 2. If one sensor fails, the process value of the error-free sensor is output.
	Minimum value	The 4 ... 20 mA output signal delivers the minimum value of the two values from sensor 1 and sensor 2. If one sensor fails, the process value of the error-free sensor is output.
	Maximum value	The 4 ... 20 mA output signal delivers the maximum value of the two values from sensor 1 and sensor 2. If one sensor fails, the process value of the error-free sensor is output.
	Difference ²⁾	The 4 ... 20 mA output signal delivers the difference between sensor 1 and sensor 2. If one sensor fails, an error signalling will be activated.
Monitoring functions		
Test current for sensor monitoring (TC)	Nom. 50 µA during test cycle, otherwise 0 µA	
Test current for sensor monitoring (RTD)	Measuring current (sensor-dependent)	
Monitoring NAMUR NE89 (monitoring of supply line resistance)	Resistance thermometer (3- and 4-wire)	Max. 50 Ω each wire
	3-wire	Monitoring of the resistance difference between lines 2 & 3 and lines 5 & 6. An error will be signalled if there is a difference of > 0.5 Ω. ³⁾
	Thermocouple	R _{Lmax} > 10 kΩ
Sensor break monitoring	Configurable via software Default: downscale	
Sensor short-circuit monitoring resistance sensor	Configurable via software Default: downscale	
Self-monitoring	Active permanently, e.g. RAM/ROM test, logical program operating checks and validity check	
Measuring range monitoring	Monitoring of the set measuring range for upper/lower deviations Standard: deactivated	
Measuring range monitoring	Monitoring of the set measuring range for upper/lower deviations Standard: Deactivated	

Output signal		
Monitoring functionality when 2 sensors have been connected (dual sensor)	Redundancy	In the case of a sensor error (sensor break, lead resistance too high or outside the measuring range of the sensor) of one of the two sensors, the process value will be only based on the error-free sensor. Once the error is rectified, the process value will again be based on the two sensors, or on sensor 1.
	Ageing control (sensor drift monitoring)	A status message via HART® occurs when the magnitude of the temperature difference between sensor 1 and sensor 2 exceeds a user-selectable value. This monitoring only generates a signal if two valid sensor values can be determined and the temperature difference is higher than the selected limit value. (Cannot be selected for the "Difference" sensor functionality, since the output signal already indicates the difference value).
	WIKA True Drift Detection	WIKA True Drift Detection technology is a specific sensor combination for the continuous monitoring of a resistance sensor. As soon as a drift is detected, this error will be signalled by the temperature transmitter via a HART® flag as a diagnostic status. A faulty measuring location is thus identified immediately and before the next recalibration. → For technical details, see special documentation SP 05.26
Voltage supply		
Auxiliary power U_B	DC 10.5 ... 42 V ⁴⁾ Attention: Restricted auxiliary power ranges for explosion-protected versions (see "Safety-related characteristic values") and extended SIL version. Load $R_A \leq (U_B - 10.5 \text{ V}) / 0.022 \text{ A}$ with R_A in Ω and U_B in V (without HART®)	
Time response		
Rise time t_{g0}	< 0.8 s ⁵⁾	
Warm-up time	After approx. 5 minutes the instrument will function to the specifications (accuracies) given in the data sheet	
Switch-on time (time to get the first measured value)	Max. 15 s	
Typical measuring rate ⁶⁾	Measured value update	<ul style="list-style-type: none"> ■ Single sensor < 6/s ■ Dual sensor < 3/s

1) Values in brackets are the default values

2) This operating mode is not allowed for the SIL option.

3) Only with SIL version

4) Auxiliary power input protected against reverse polarity. On switching on (24 V (load = 500 Ω)), an increase in the auxiliary power of at least 4 V/s is needed; otherwise the temperature transmitter will remain in a safe state at 3.5 mA.

5) < 1.0 s with FLR sensor

6) For the FLR sensor, double values can be assumed.

Electrical connections

Wire cross-section

T38.H head-mounted version	Solid wire	0.2 ... 2.5 mm ² (24 ... 14 AWG)
	Stranded wire with end splice	0.14 ... 1.5 mm ² (26 ... 16 AWG)
T38.R rail-mounted version	Solid wire	0.2 ... 2.5 mm ² (24 ... 14 AWG)
	Stranded wire with end splice	0.14 ... 2.5 mm ² (26 ... 14 AWG)
Lead resistance ¹⁾		
Resistance sensor	Max. 50 Ω each wire, 3-/4-wire connection	
Thermocouple	Max. 10 kΩ	
Insulation voltage (input to analogue output)	AC 1,500 V, (50 Hz / 60 Hz); 60 s	

1) Monitoring of the lead resistance can be switched off (does not apply to SIL). If exceeded, the specified accuracy specifications no longer apply.

Assignment of connection terminals

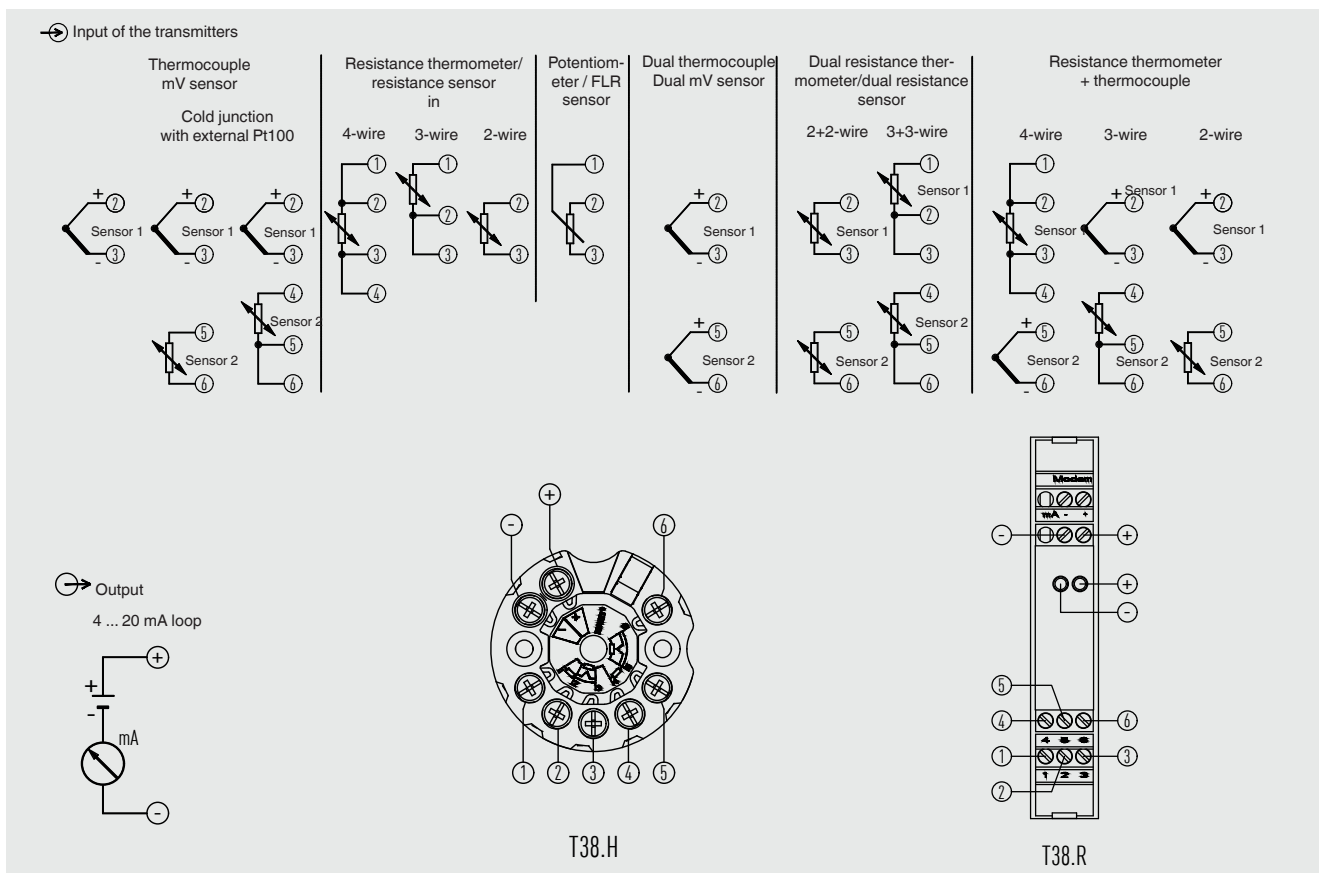

Version with display TND

Operation/display:

The display shows a current measured value and additional information about which value it is (PV, S1-S2, etc.). The selection of the displayed value can be made via the configuration tool.

Should the transmitter detect an error in the measuring chain, this will be shown on the display with the channel number and the error code.

T38 with clip-on display (TND)



PIH-W with T38 and TND



When installing a head-mounted transmitter with a display in a case, it must be ensured that a case with a window in the cover is used. The WIKA PIH-W case, specifically developed for this application, is available for the combination of a T38 with a TND clip-on display (see figure “PIH-W with T38 and TND” and accessories).

Adjustment of sensors

One method to improve the accuracy of the temperature measurement can be carried out by using Callendar–Van Dusen coefficients (platinum resistance thermometer).

The Callendar–Van Dusen equation is described as:

$$R_t = R_0[1 + AT + BT^2 + C(T - 100)T^3]$$

For best accuracy of the system, a platinum resistance thermometer (RTD) should be individually calibrated to generate the A, B, C coefficients.

→ For further information, see technical information IN 00.29

Materials

Non-wetted parts

T38.H head-mounted version	Plastic, PBT, glass-fibre reinforced
T38.R rail-mounted version	Plastic

Operating conditions	
Ambient temperature	
Standard	-40 ... +85 °C [-40 ... +185 °F]
Extended for high ambient temperatures ¹⁾	-40 ... +105 °C [-40 ... +221 °F]
Extended for low ambient temperatures ¹⁾	-50 ... +85 °C [-58 ... +185 °F]
Advanced for SIL ²⁾	-40 ... +95 °C [-40 ... +203 °F]
Storage temperature	-40 ... +85 °C [-40 ... +185 °F]
Maximum allowable humidity	
T38.H head-mounted version IEC 60068-2-38:2022	Test of max. temperature variation 65 °C [149 °F] and -10 °C [14 °F], 95 % r. h.
T38.R rail-mounted version IEC 60068-2-30:1999	Test of max. temperature 25 °C [77 °F] and 55 °C [131 °F], 80 % r. h.
Climate class per IEC 60654-1: 1993 ³⁾	Cx (-40 ... +85 °C [-40 ... +185 °F], 5 ... 95 % r. h.)
Salt mist per IEC 60068-2-52: 2017	Severity grade 1
Vibration resistance per IEC 60068-2-6:2008	Test Fc: 10 ... 2,000 Hz, 10 g, amplitude 0.75 mm [0.03 in]
Shock resistance per IEC 60068-2-27: 2008	Acceleration / shock width
T38.H head-mounted version	100 g / 6 ms
T38.R rail-mounted version	15 g / 11 ms
Free fall in line with IEC 60721-3-2:2018	1.5 m [4.9 ft]
Ingress protection of the complete instrument (per IEC 60529)	
T38.H head-mounted version	IP00 (electronics completely potted)
T38.R rail-mounted version	IP20
Electromagnetic compatibility (EMC) in accordance with EN 55011:2022, EN IEC 61326, NAMUR NE21:2017	Emission (group 1, class B) and immunity (industrial application) [HF field, HF line, ESD, burst and surge]

1) Special version, not for rail-mounted version, not for SIL version



2) Special version, not for rail-mounted version

3) Not for rail-mounted version



Approvals

Logo	Description	Region
	EU declaration of conformity	European Union
	EMC directive	
	EN 61326 emission (group 1, class B) and immunity (industrial environments)	
	RoHS directive	

Optional approvals

Logo	Description	Region	
	EU declaration of conformity	European Union	
	ATEX directive Hazardous areas		
	Ex i - Head-mounted version Zone 0 gas Zone 20 dust Zone 2 gas		II 1G Ex ia IIC T6...T4 Ga II 1D Ex ia IIIC T135 °C Da II 3G Ex ic IIC T6...T4 Gc X
	- Rail-mounted version Zone 0, 1 gas Zone 20, 21 dust		II 2(1)G Ex ia [ia Ga] IIC T6...T4 Gb II 2(1)D Ex ia [ia Da] IIIC T135°C Db
Ex e Zone 2 gas	II 3G Ex ec IIC T6...T4 Gc X		
	IECEx Hazardous areas	International	
	Ex i - Head-mounted version Zone 0 gas Zone 20 dust Zone 2 gas		Ex ia IIC T6...T4 Ga Ex ia IIC T135 °C Da Ex ic IIC T6...T4 Gc
	- Rail-mounted version Zone 0, 1 gas Zone 20, 21 dust		Ex ia [ia Ga] IIC T6...T4 Gb Ex ia [ia Da] IIIC T135 °C Db
	- Ex e Zone 2 gas		Ex ec IIC T6...T4 Gc

Manufacturer's information and certificates

Logo	Description
	SIL 2 Functional safety
-	China RoHS directive
	NAMUR <ul style="list-style-type: none"> ■ EMC per NAMUR NE21 ■ Signalling per NAMUR NE43 ■ Sensor break monitoring per NAMUR NE89 ■ Self-monitoring and diagnostics of field instruments in accordance with NAMUR NE107 ■ Uniform representation of the measuring deviation of field instruments in accordance with NAMUR NE145 ■ Field instruments for standard applications in accordance with NAMUR NE131

Certificates (option)

Certificates	
Certificates	<ul style="list-style-type: none"> ■ 2.2 test report ■ 3.1 inspection certificate
Calibration	DAkkS calibration certificate

→ For approvals and certificates, see website

Safety-related characteristic values (Ex)

	Model T38.*-AI** Gas hazardous applica- tion	Model T38.*-AC** Gas hazardous applica- tion	Model T38.*-AI** Dust hazardous applica- tion
Ex marking			
Head-mounted version	II 1G Ex ia IIC T6...T4 Ga	II 3G Ex ic IIC T6...T4 Gc	II 1D Ex ia IIIC T135° Da
Rail-mounted version	II 2(1)G Ex ia [ia Ga] IIIC T6...T4 Gb	II 3G Ex ic IIC T6...T4 Gc	II 2(1)D Ex ia [ia Da] IIIC T135 °C Db
Connection values / Intrinsically safe supply and signal circuit (4 ... 20 mA current loop)			
Terminals	+ / -	+ / -	+ / -
Auxiliary power U_B ¹⁾	DC 10.5 ... 30 V	DC 10.5 ... 30 V	DC 10,5 ... 30 V
Maximum voltage U_i	DC 30 V	DC 30 V	DC 30 V
Maximum current I_i	130 mA	130 mA	130 mA
Maximum power P_i	800/600 mW	800/600 mW	750 / 650 / 550 mW
Effective internal capacitance C_i	1.7 nF	1.7 nF	1.7 nF
Effective internal inductance L_i	Negligible	Negligible	Negligible

1) Auxiliary power input protected against reverse polarity. When switching on (24 V (load = 500 Ω)), an increase of the auxiliary power of at least 4 V/s is required, otherwise the temperature transmitter remains in the safe state at 3.5 mA.

Further specifications on: Safety-related characteristic values (Ex)

	Model T38.*-AE** Ex ia IIC/IIB/IIA Ex ia IIIC	Model T38.x-AC Ex ic IIC/IIB/IIA
Connection values of sensor circuit		
Terminals	1 - 6	1 - 6
Maximum voltage U_0	DC 6.32 V	DC 6.32 V
Maximum current I_0	25 mA	25 mA
Maximum power P_0	39 mW	39 mW
Maximum external capacitance C_0	24 μF	325 μF
Maximum external inductance L_0	50 mH	120 mH
Maximum inductance/resistance ratio L_0/R_0	0.8 mH/Ω	1.55 mH/Ω
Characteristic curve	Linear	

	Model T38.*-AE** Gas hazardous application
Ex marking	II 3G Ex ec IIC T6 ... T4 Gc
Connection values / Intrinsically safe supply and signal circuit (4 ... 20 mA current loop)	
Terminals	+ / -
Voltage U_n	DC 40 V
Current I_n	22.5 mA

	Model T38.*-AE**
Connection values of sensor circuit	
Terminals	1-6
Voltage U_n	DC 3 V
Current I_n	0.66 mA
Power P_n	2 mW

Application	Ambient temperature range	Temperature class	Power P _i
Group II Gas	-50 ... +105 °C [-58 ... 221 °F]	T4	600 mW
	-50 ... +85 °C [-58 ... 185 °F]	T4	800 mW
	-50 ... +75 °C [-58 ... 167 °F]	T5	800 mW
	-50 ... +60 °C [-58 ... 140 °F]	T6	600 mW
	-50 ... +50 °C [-58 ... 122 °F]	T6	800 mW
Group III Dust	-50 ... +40 °C [-58 ... 104 °F]	T135 °C	750 mW
	-50 ... +70 °C [-58 ... 158 °F]	T135 °C	650 mW
	-50 ... +100 °C [-58 ... 212 °F]	T135 °C	550 mW

Dimensions in mm [in]

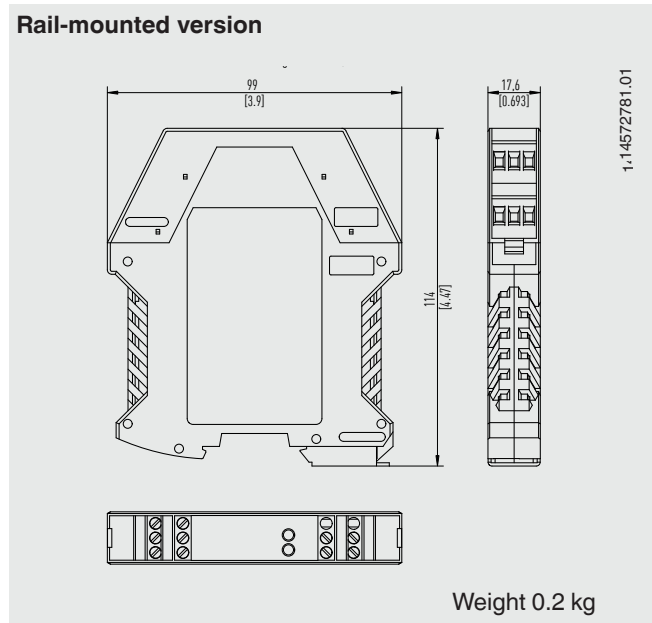
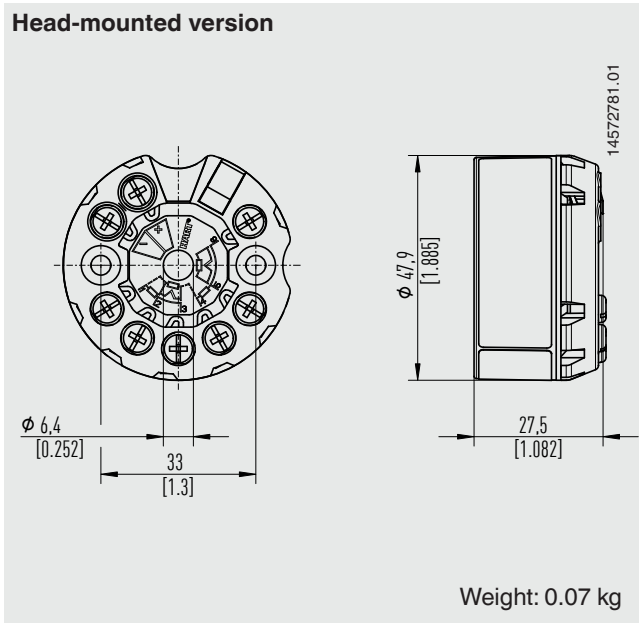

Communication

HART® protocol rev. 7.6

Interoperability (i.e. compatibility between components from different manufacturers) is a strict requirement of HART® instruments. The T38 transmitter is compatible with almost every open software and hardware tool; including:

1. User-friendly WIKAsoft-TT WIKA configuration software, free-of-charge download from www.wika.com
2. HART® communicator (e.g. AMS Trex):
T38 device description (device object file) is integrated
3. Asset management systems
 - 3.1 Complete, EDDL/FDI-compliant Device Description (DD) with FDI device package: e.g. for Emerson AMS, Simatic PDM
 - 3.2 Device Type Manager (DTM): e.g. for PACTware, FieldMate

Attention:

For direct communication via the serial interface of a PC/notebook, a HART® modem is needed (see "Accessories"). As a general rule, parameters which are defined in the scope of the universal HART® commands can, in principle, be edited with all HART® configuration tools.

Configuration

Typical connection in hazardous area

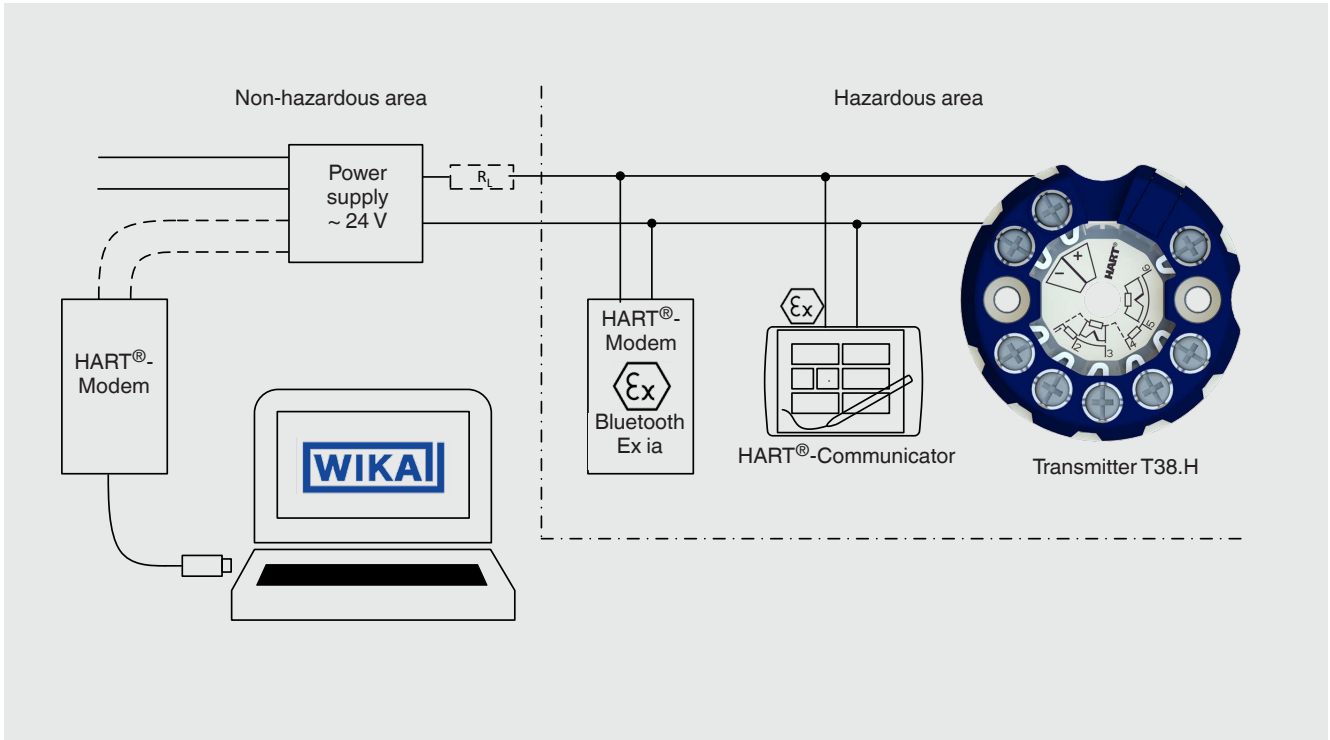

Typical connection in non-hazardous area

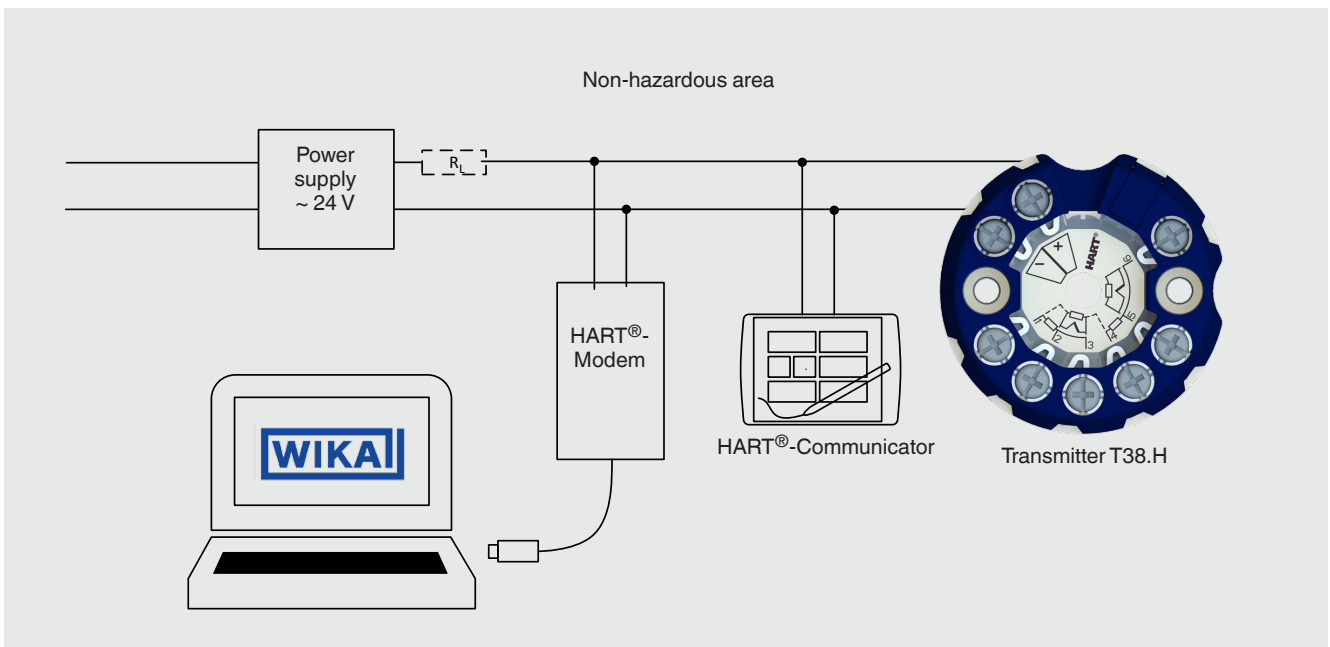

R_L = Load resistance for HART® communication
 R_L min. 230 Ω , max. 1,431 Ω

Example calculation

$$R_{MAX} @ 24V = (24V - 10,5 V) / 22 \text{ mA} = 613 \Omega$$

$$R_{MAX} @ 42V = (42V - 10,5 V) / 22 \text{ mA} = 1431 \Omega$$

$$U_{B_MIN} @ 230 \Omega = (230 \Omega * 22 \text{ mA}) + 10,5 V = 15,6 V$$

If R_L is < 230 Ω in the respective circuit, R_L must be increased to at least 230 Ω by connecting external resistors.

Connecting the PU-548 programming unit



Attention:

For direct communication via the serial interface of a PC/notebook, a model PU-548 programming unit is needed (see “Accessories” on page 17).

Configuration software WIKAsoft-TT

WIKAsoft-TT

:: Digital temperature transmitter ::

File Instrument ?

COM port: COM5

Configuration Diagnostics

Load instrument data Load configuration Reset to Factory Defaults

Instrument data HART Data

Transmitter model code: T38.H-ZZZZZ

Serial number: 1A02PLRTT40

Firmware: V 0.9.3

Maximum instrument temperature: -60 °C

Permissible ambient temperature: -40 ... 85 °C

Manufacturing Date: 29.09.2023

Hours of operation: 0

TAG Long: TAG

Description: []

User message: []

TAG no.: []

Input

Sensor type: Pt100

Error signaling (NAMUR): All errors uniform

Process adaption: no adaption

Wire connection: 3-wire

Measuring range: 0 ... 150 °C

Damping: 0 Seconds





Configuration protocol Write to instrument

Accessories

WIKA configuration software: Free download from www.wika.com

Model	Description	Order number
	DIH50, DIH52 with field case DIH50 display module without separate auxiliary power supply, automatically rescales on a change in measuring range and units via monitoring of the HART® communication, 5-digit LC display, 20-segment bar graph display, display rotatable in 10° steps, with II 1G EEx ia IIC explosion protection Material: Aluminium / stainless steel Dimensions: 150 x 127 x 138 mm → For further information, see data sheet AC 80.10	On request
	PIH-X Connection head Modular connection heads, can be combined with T38 transmitter as a complete instrument; Available with window -> installation of the TND possible Impressive stability in accordance with C5-M (without mounting parts) With explosion protection Material: Aluminium → For further specifications, see data sheet AC 80.12	On request
	TND - Temperature Numerical Display Indication module TND, 5-digit LC display	33025404
	Programming unit model PU-548 Programming unit for USB interface for use with the WIKAsoft-TT configuration software Easy to use LED status indication Compact design No further voltage supply needed, neither for the programming unit nor for the transmitter Incl. 1 model magWIK magnetic quick connector	14231581
	Adapter Suitable for TS 35 per DIN EN 60715 (DIN EN 50022) or TS 32 per DIN EN 50035 Material: Plastic / stainless steel Dimensions: 60 x 20 x 41.6 mm	On request
	Adapter Suitable for TS 35 per DIN EN 60715 (DIN EN 50022) Material: Steel, tin-plated Dimensions: 49 x 8 x 14 mm	On request
	Magnetic quick connector, model magWIK Replacement for crocodile clips and HART® terminals Fast, safe and tight electrical connection For all configuration and calibration processes	14026893

HART® modem

Model	Description	Order number
Programming unit, model PU-H		
	VIATOR® HART® USB HART® modem for USB interface	11025166
	VIATOR® HART® USB PowerXpress™ HART® modem for USB interface	14133234
	VIATOR® HART® RS-232 HART® modem for RS-232 interface	7957522
	VIATOR® HART® Bluetooth® Ex HART® modem for Bluetooth interface, Ex	11364254

Ordering information

Model / Explosion protection / SIL specifications / Configuration / Permissible ambient temperature / Certificates / Options

© 04/2023 WIKA Alexander Wiegand SE & Co. KG, all rights reserved.
The specifications given in this document represent the state of engineering at the time of publishing.
We reserve the right to make modifications to the specifications and materials.

